

Series
VENTS VCN



Exhaust centrifugal fans in steel casing with the air capacity up to **710 m³/h** for outdoor surface mounting.

■ **Applications**

Exhaust ventilation system for various premises designed for air exhaust with the temperature up to 55°C. Direct air exhaust is provided.

■ **Design**

Steel casing with polymeric coating ensures motor protection against direct humidity exposure in case of the unit outdoor mounting. The fan bottom has a bird and rodent proof guard. Air is exhausted vertically down.

■ **Motor**

The centrifugal impeller with backward curved blades is powered by the single-phase motor with external rotor and overheating protection with automatic restart. The motor is equipped with ball bearings for long service life designed for at least 40 000 hours. For precise features, safe operation and low noise, each turbine is dynamically balanced while assembly. Motor protection rating IP 44.

■ **Speed control**

Smooth or step speed control is performed with the thyristor or autotransformer controller. Several fans can be connected to one controller in case their total power and operating current do not exceed the rated controller values.

■ **Mounting**

The fan is designed for outdoor surface wall mounting and connection to round duct of the respective diameter. The fan is powered through the external terminals. Electric connection and mounting shall be performed in compliance with the manual and wiring diagram provided in unit operation manual.



The motor is protected against direct water drops and solid objects.



VCN fan WC ventilation example.

Designation key: _____

Fan series
VENTS VCN

Flange diameter
100; 125; 150; 160; 200

Accessories



page 240

page 294

page 295

page 296

page 305

page 310

page 310

page 311

page 311

page 314

page 315

Technical data:

	VCN 100	VCN 125	VCN 150	VCN 160	VCN 200
Voltage [V / 50 Hz]	230	230	230	230	230
Power [W]	58	60	100	102	104
Current [A]	0,26	0,27	0,43	0,44	0,45
Maximum air flow [m ³ /h]	280	390	600	650	710
RPM [min ⁻¹]	2500	2500	2600	2600	2600
Noise level at 3 m [dBA]	54	54	58	60	62
Maximum operating temperature [°C]	55	55	55	55	55
Protection rating	IP X4	IP X4	IP X4	IP X4	IP X4

Fan overall dimensions:

Type	Dimensions [mm]				Mass [kg]
	∅D	B	H	L	
VCN 100	99	260	355	138	4,1
VCN 125	124	260	355	138	4,1
VCN 150	149	300	400	138,2	4,5
VCN 160	159	300	400	138,2	4,5
VCN 200	199	300	400	138,2	4,5

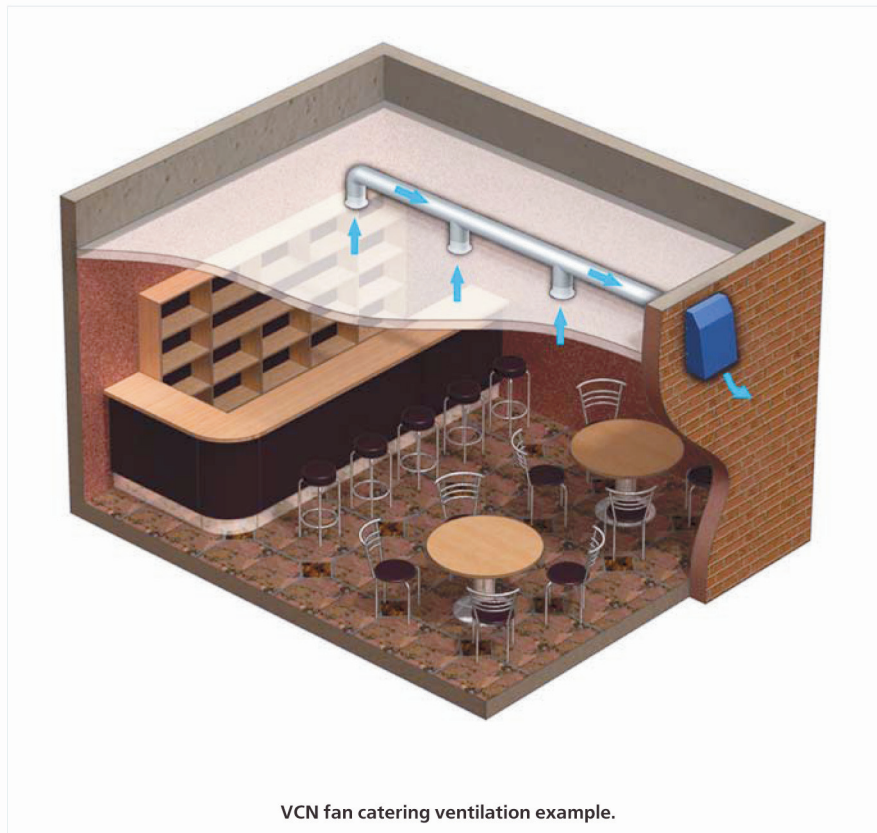
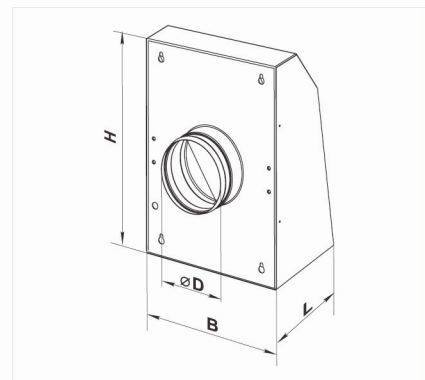

VENTS VCN

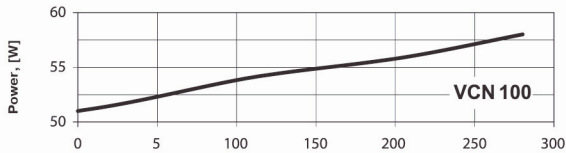
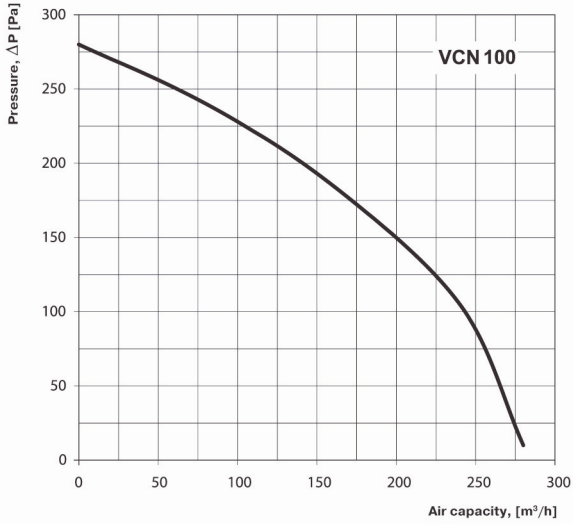

Sound-power level	Hz	Octave-frequency band [Hz]								
		Gen	63	125	250	500	1000	2000	4000	8000
L_{wA} to inlet	dBA	60	46	52	58	58	58	51	40	28
L_{wA} to environment	dBA	58	39	40	49	55	60	56	43	35

VENTS VCN

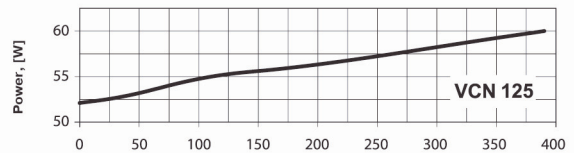
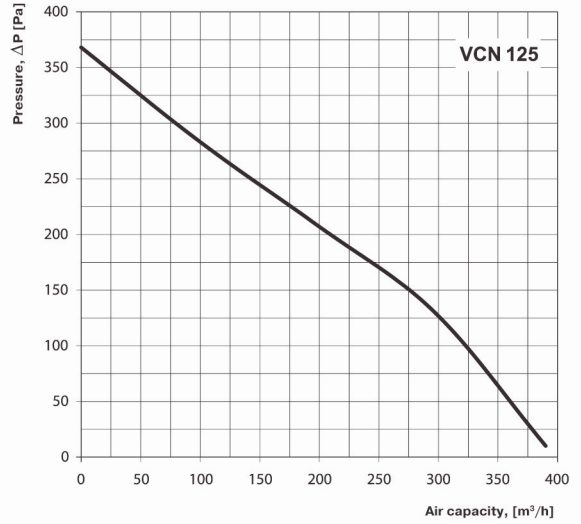

Sound-power level	Hz	Octave-frequency band [Hz]								
		Gen	63	125	250	500	1000	2000	4000	8000
L_{wA} to inlet	dBA	58	48	54	59	56	57	52	42	29
L_{wA} to environment	dBA	59	41	41	52	55	58	54	46	35

VENTS VCN

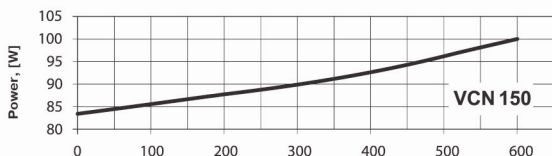
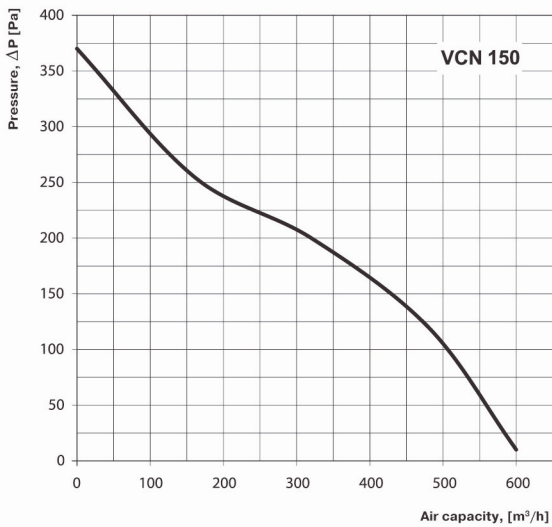

Sound-power level	Hz	Octave-frequency band [Hz]								
		Gen	63	125	250	500	1000	2000	4000	8000
L_{wA} to inlet	dBA	57	45	53	54	57	56	46	38	19
L_{wA} to environment	dBA	56	48	38	48	52	54	49	39	32

VENTS VCN

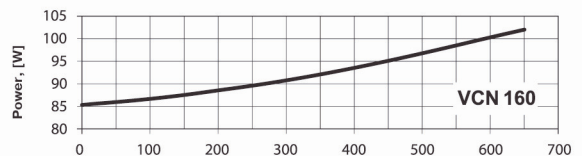
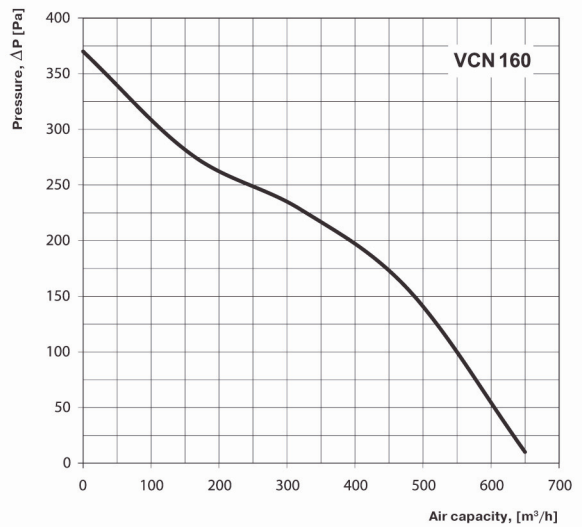

Sound-power level	Hz	Octave-frequency band [Hz]								
		Gen	63	125	250	500	1000	2000	4000	8000
L_{wA} to inlet	dBA	55	44	54	55	58	54	46	36	18
L_{wA} to environment	dBA	54	46	39	49	51	53	49	42	31



VENTS VCN

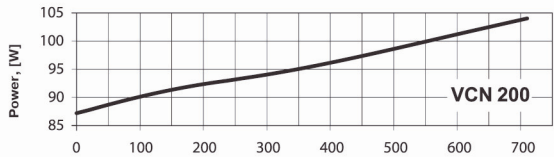
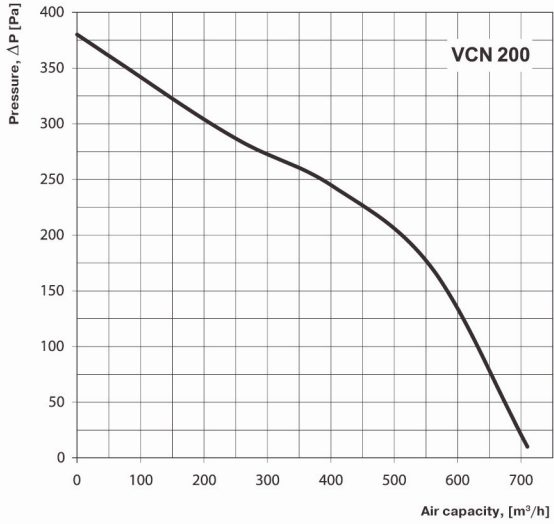

Sound-power level	Hz	Gen	Octave-frequency band [Hz]							
			63	125	250	500	1000	2000	4000	8000
L_{WA} to inlet	dBA	59	48	55	50	58	58	48	41	23
L_{WA} to environment	dBA	55	47	39	51	55	53	52	38	33